

Osptek Display

OLED SPECIFICATION

Model No:

OED195-25664F001-C23

osptek[®]

REVISION RECORD

REV.	REVISION DESCRIPTION	REV. DATE	REMARK
X01	INITIAL RELEASE	2024. 04. 10	



CONTENTS

ITEM	PAGE
<u>1. SCOPE</u>	4
<u>2. WARRANTY</u>	4
<u>3. FEATURES</u>	4
<u>4. MECHANICAL DATA</u>	5
<u>5. MAXIMUM RATINGS</u>	6
<u>6. ELECTRICAL CHARACTERISTICS</u>	6
6.1 D.C ELECTRICAL CHARACTERISTICS	
6.2 ELECTRO-OPTICAL CHARACTERISTICS	
<u>7. LIFETIME EXPECTANCY</u>	8
<u>8. INTERFACE</u>	9
8.1 FUNCTION BLOCK DIAGRAM	
8.2 PANEL LAYOUT DIAGRAM	
8.3 PIN ASSIGNMENTS	
8.4 GRAPHIC DISPLAY DATA RAM ADDRESS MAP	
8.5 INTERFACE TIMING CHART	
<u>9. POWER ON / OFF SEQUENCE & APPLICATION CIRCUIT</u>	13
9.1 POWER ON / OFF SEQUENCE	
9.2 APPLICATION CIRCUIT	
9.3 COMMAND TABLE	
<u>10. RELIABILITY TEST CONDITIONS</u>	15
<u>11. EXTERNAL DIMENSION</u>	16
<u>12. PACKING SPECIFICATION</u>	17
<u>13. OUTGOING INSPECTION PROVISION</u>	18
<u>14. APPENDIXES</u>	25

1. SCOPE

The purpose of this specification is to define the general provisions and quality requirements that apply to the supply of display cells manufactured by Osptek. This document, together with the Module Ass'y Drawing, is the highest-level specification for this product. It describes the product, identifies supporting documents and contains specifications.

2. WARRANTY

Osptek warrants that the products delivered pursuant to this specification (or order) will conform to the agreed specifications for 12 months from the shipping date ("Warranty Period"). Osptek is obligated to repair or replace the products which are found to be defective or inconsistent with the specifications during the Warranty Period without charge, on condition that the products are stored in the original packages at $25^{\circ}\text{C}\pm 5^{\circ}\text{C}$, $55\%\pm 10\%\text{RH}$ or used as the conditions specified in the specifications.

Nevertheless, Osptek is not obligated to repair or replace the products without charge if the defects or inconsistency are caused by the force majeure or the reckless behaviors of the customer.

After the Warranty Period, all repairs or replacements of the products are subject to charge.

3. FEATURES

- Small molecular organic light emitting diode.
- Color : Full Color
- Panel matrix : 256(RGB) x 64
- Driver IC : LD7226
- Excellent quick response time.
- Extremely thin thickness for best mechanism design : 1.43 mm(with Polarizer)
- High contrast : 10,000:1
- Wide viewing angle : 160°
- Serial Peripheral Interface
- Strong environmental resistance.
- Wide range of operating temperature: -20 to 85°C .
- Circular Polarizer .

4. MECHANICAL DATA

NO	ITEM	SPECIFICATION	UNIT
1	Dot Matrix	256(W) x 3 x 64(H)	dot
2	Dot Size	0.0427 (W) x 0.162 (H)	mm ²
3	Dot Pitch	0.0627 (W) x 0.186 (H)	mm ²
4	Aperture Rate	59	%
5	Active Area	48.103 (W) x 11.88 (H)	mm ²
6	Panel Size	52.7 (W) x 22.3 (H)	mm ²
7*	Panel Thickness	1.43 ± 0.15	mm
8	Module Size	52.7 (W) x 52.3 (H) x 1.43 (D)	mm ³
9	Diagonal A/A size	1.95	inch
10	Module Weight	TBD	gram

* Panel thickness includes substrate glass, cover glass and UV glue thickness.



5. MAXIMUM RATINGS

ITEM	MIN	MAX	UNIT	Condition	Remark
Supply Voltage (V_{DD})	-0.3	6	V	$T_a = 25^\circ\text{C}$	IC maximum rating
Supply Voltage (V_{CC})	-0.5	20	V	$T_a = 25^\circ\text{C}$	IC maximum rating
Operating Temp.	-20	85	$^\circ\text{C}$	-	Note (2)
Storage Temp	-40	90	$^\circ\text{C}$	-	Note (2)

Note:

- (1) Maximum ratings are those values beyond which damages to the OLED module may occur. The OLED functional operation should be restricted to the limits in the section 6. Electrical Characteristics tables.
- (2) The defined temperature ranges do not include the polarizer. The maximum withstood temperature of the polarizer should be 80°C .

6. ELECTRICAL CHARACTERISTICS

6.1 D.C ELECTRICAL CHARACTERISTICS

SYMBOL	PARAMETER	TEST CONDITION	MIN	TYP	MAX	UNIT
V_{DD}	Logic Supply Voltage	$T_a = 25^\circ\text{C}$	1.65	2.8	3.5	V
V_{CC}	Operating Voltage (for OLED panel)	$T_a = 25^\circ\text{C}$	15.5	16	16.5	V
V_{IH}	High Logic Input Level	-	$0.8 * V_{DD}$	-	V_{DD}	V
V_{IL}	Low Logic Input Level	-	0	-	$0.2 * V_{DD}$	V

6.2 ELECTRO-OPTICAL CHARACTERISTICS

PANEL ELECTRICAL SPECIFICATIONS

PARAMETER	MIN	TYP.	MAX	UNITS	COMMENTS
Normal mode current consumption (ICC)	-	TBD	TBD	mA	All pixels on (1)
	-	TBD	TBD	mA	50% pixels on (1)
	-	TBD	TBD	mA	20% pixels on (1)
Standby mode current consumption (ICC)	-	TBD	TBD	mA	Standby mode 10% pixels on (2)
Normal mode power consumption		TBD	TBD	mW	All pixels on (1)
		TBD	TBD	mW	50% pixels on (1)
		TBD	TBD	mW	20% pixels on (1)
Standby mode power consumption		TBD	TBD	mW	Standby mode 10% pixels on (2)
ICC Sleep mode Current	-	-	TBD	uA	Sleep mode Current (3)
IDD Sleep mode Current	-	-	TBD	uA	Sleep mode Current (3)
Normal Luminance	280	320	-	cd/m ²	Display Average
Standby mode	-	30	-	cd/m ²	Display Average
CIE _x (White)	0.26	0.30	0.34		x, y (CIE 1931)
CIE _y (White)	0.29	0.33	0.37		
CIE _x (Red)	0.62	0.66	0.70		
CIE _y (Red)	0.29	0.33	0.37		
CIE _x (Green)	0.26	0.30	0.34		
CIE _y (Green)	0.59	0.63	0.67		
CIE _x (Blue)	0.10	0.14	0.18		
CIE _y (Blue)	0.14	0.18	0.22		
Dark Room Contrast	10,000:1				
Viewing Angle	160			degree	

Note:

(1) Normal mode condition :

- V_{CC} = 16V
- Contrast setting : TBD
- Duty setting : 1/64
- Frame rate: 105Hz

(2) Standby mode condition :

- V_{CC} = 16V
- Contrast setting : TBD
- Duty setting : 1/64
- Frame rate: 105Hz

Note: More setting refer to application note.

7. LIFETIME SPECIFICATION

ITEM	MIN	UNIT	Condition	Remark
Life Time	10,000	Hrs	320 cd/m ² , 50% alternating checkerboard	Note (1)

Note:

Lifetime Expectancy is not guaranteed one but expected lifetime in normal condition.

(A) Under $V_{cc} = 16V$, $T_a = 25^{\circ}C$, 50% RH.

(B) Life time is defined the amount of time when the luminance has decayed to less than 50% of the initial measured luminance.

(1) Setting of 320 cd/m² :

- Contrast setting : TBD
- Frame rate : 105Hz
- Duty setting : 1/64



8. INTERFACE

8.1 FUNCTION BLOCK DIAGRAM

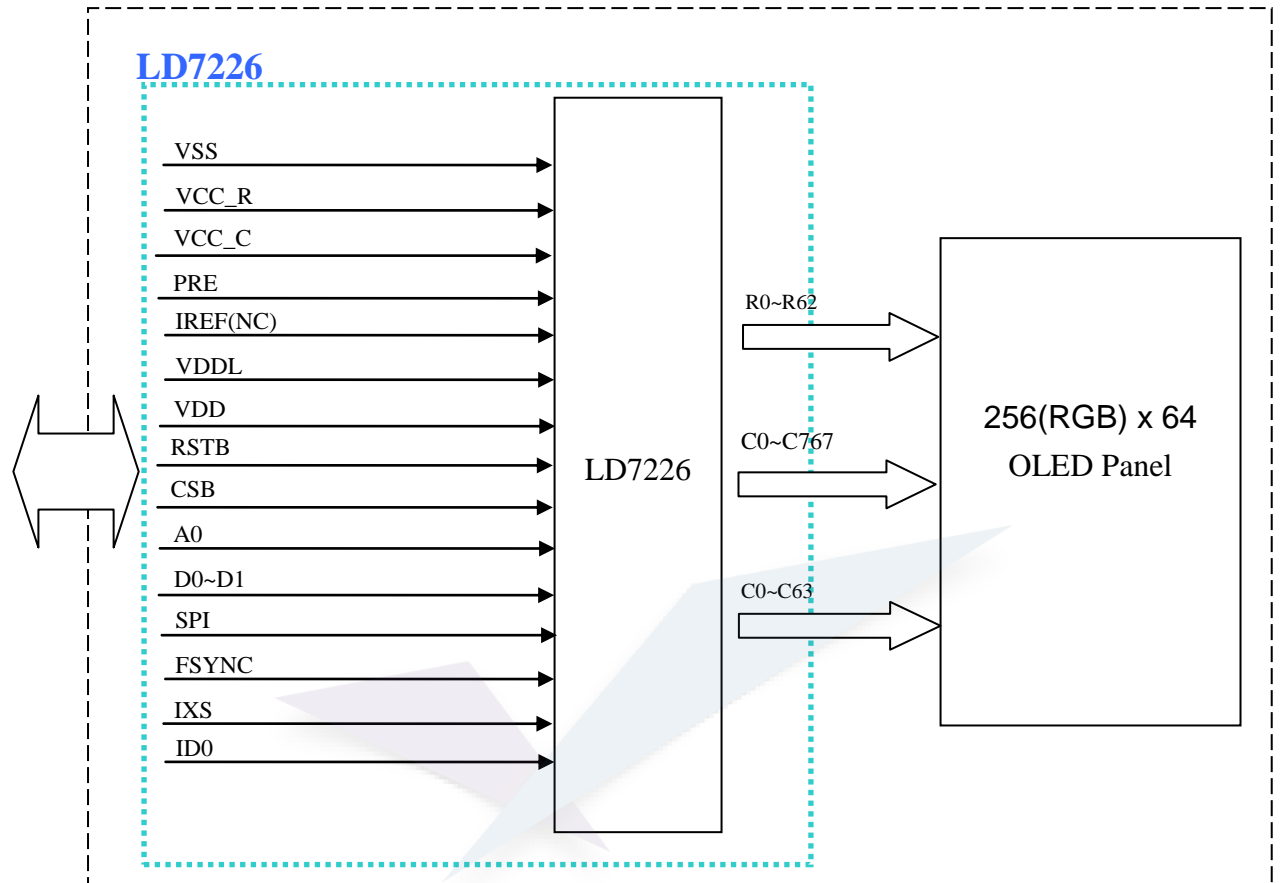

Osptek 256(RGB)x64 OLED

osptek®

8.2 PANEL LAYOUT DIAGRAM

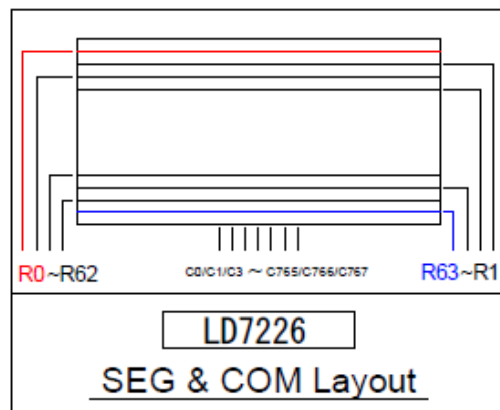

8.3 PIN ASSIGNMENTS

PIN No.	PIN Name.	DESCRIPTION	Setting at each interface		
			3-SPI	4-SPI	IIC
1	VSS	Ground			
2	VCC_R	COMH Voltage			
3	VCC_C	OLED Driving Voltage			
4	PRE	Ground			
5	IREF(NC)	Segment Current Reference Pin (NC)			
6	VDDL	Core Voltage			
7	VDD	Logic Power Voltage			
8	RSTB	Reset	RSTB	RSTB	
9	CSB	Chip Select	CSB	CSB	
10	A0	Data/Command Selection		A0	
11	D0(SCLK)	Serial Clock	D0(SCLK)	D0(SCLK)	
12	D1(SDIN)	Data Input	D1(SDIN)	D1(SDIN)	
13	SPI	Interface Control Pin	Pull High	Pull Low	
14	FSYNC	Frame Signal			
15	LSNC(NC)	Line Signal & Oscillator Clock output (NC)			
16	IXS	Test pad, should be tied VSS			
17	ID0	I2C Interface Address	Pull Low	Pull Low	
18	VDD	Logic Power Voltage			
19	VDDL	Core Voltage			
20	PRE	Ground			
21	VCC_C	OLED Driving Voltage			
22	VCC_R	COMH Voltage			
23	VSS	Ground			

Note

- (1) Low is connected to VSS
- (2) High is connected to VDD

8.4 GRAPHIC DISPLAY DATA RAM ADDRESS MAP

The size of the RAM is 256x96x 18bits. 18 bit is allocated for each pixels.

The bit of R, G and B are corresponding to 6bit, 6bit and 6bit, respectively.

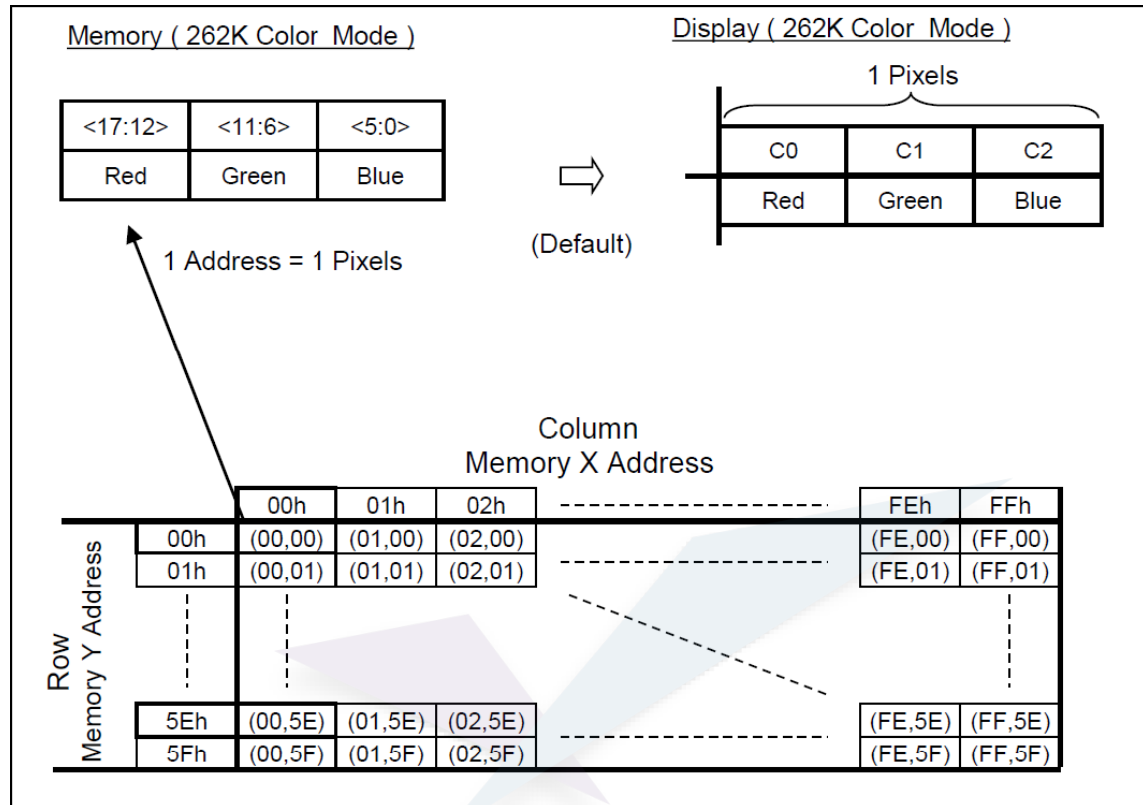

This OLED specification is in 65K color mode which transmits R, G and B data in 5 bits, 6 bits and 5 bits respectively.

The transmission data and writing to the memory are as shown in the figure below.

8.5 INTERFACE TIMING CHART(For 4-SPI)

(TA = 25°C)

symbol	Parameter	Min	Typ	Max	Unit
tcys	Serial clock cycle	66	-	-	ns
tpWH	High pulse Width	20	-	-	ns
tpWL	Low pulse width	20	-	-	ns
tASS	A0 setup time	15	-	-	ns
tAHS	A0 hold time	25	-	-	ns
tdSS	Data setup time	20	-	-	ns
tdHS	Data hold time	20	-	-	ns
tcSS	Chip select setup time	20	-	-	ns
tcSH	Chip select hold time	50	-	-	ns
tcSHW	Chip select high pulse width	50	-	-	ns
tsCC	SCL to Chip select	15	-	-	ns

NOTE: The input signal rise time and fall time (t_r, t_f) is specified at 15ns or less.

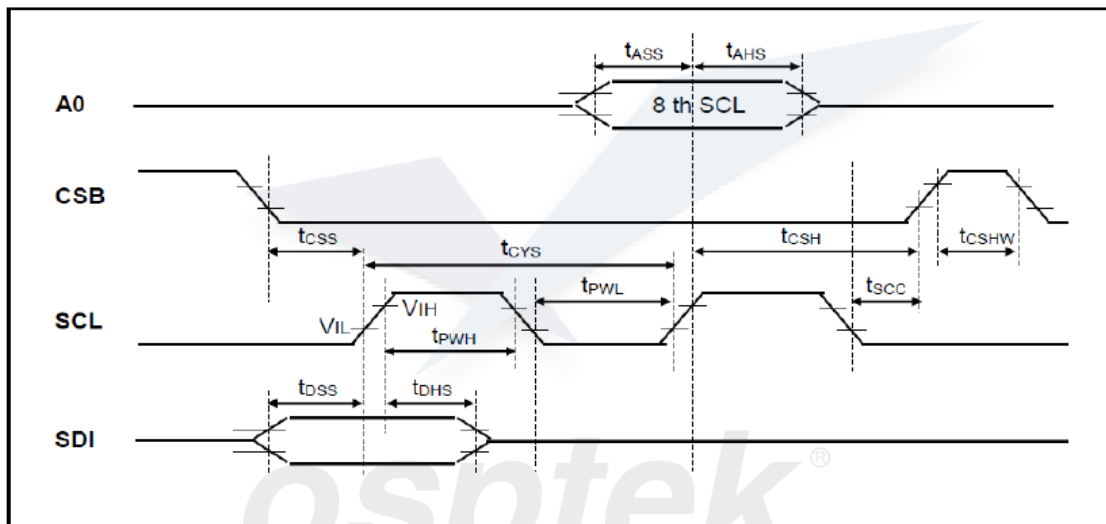

Input Signal Slope

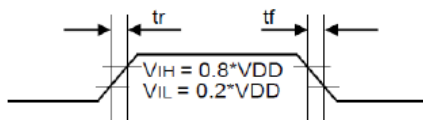

Output Signal Slope

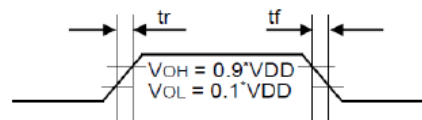

9. POWER ON / OFF SEQUENCE & APPLICATION CIRCUIT

9.1 POWER ON / OFF SEQUENCE

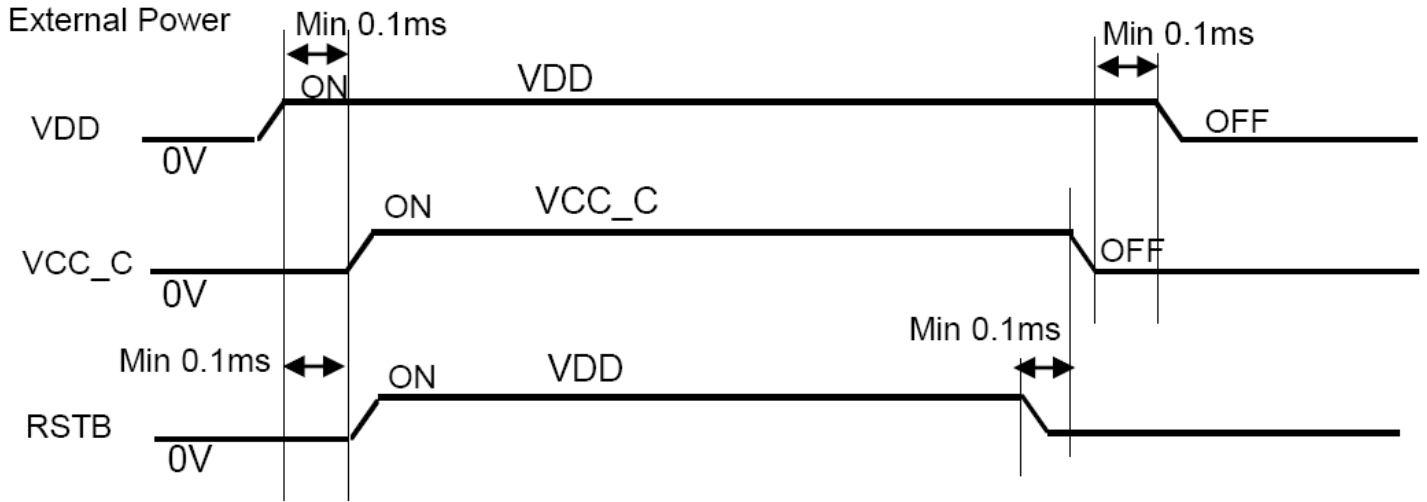

osptek[®]

9.2 APPLICATION CIRCUIT (FOR 4-SPI)

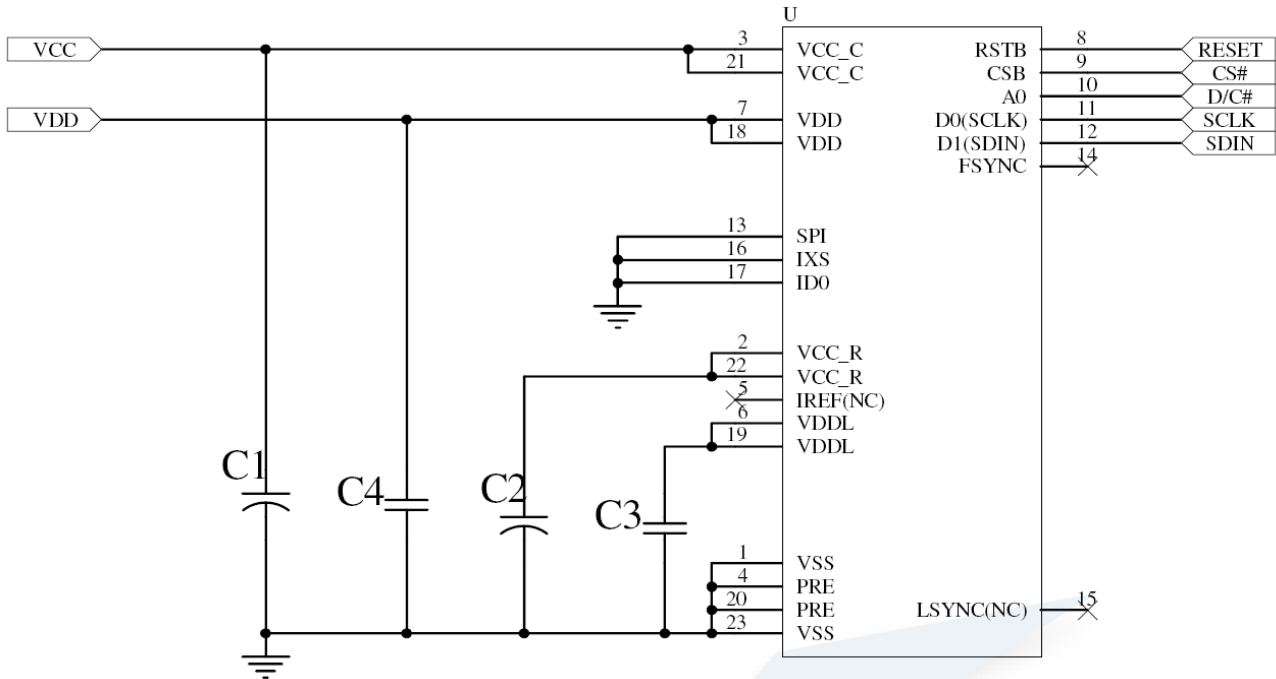

Recommend components:

C1, C2: 4.7uF/25V (Tantalum type) or VISHAY (572D475X0025A2T)
 C3, C4: 1uF/16V (0603)

Note:

1. More setting refers to application note.
2. The circuit is for 4-SPI interface.

9.3 COMMAND TABLE

Refer to LD7226 IC Spec.

10. RELIABILITY TEST CONDITIONS

No.	Items	Specification	Quantity
1	High temp. (Non-operation)	85°C, 240hrs	5
2	High temp. (Operation)	70°C, 240hrs	5
3	Low temp. (Operation)	-20°C, 240hrs	5
4	High temp. / High humidity (Operation)	65°C, 90%RH, 240hrs	5
5	Thermal shock (Non-operation)	-40°C ~85°C (-40°C /30min; transit /3min; 85°C /30min; transit /3min) 1cycle: 66min, 100 cycles	5
6	Vibration	Frequency : 5~50HZ, 0.5G Scan rate : 1 oct/min Time : 2 hrs/axis Test axis : X, Y, Z	1 Carton
7	Drop	Height: 80cm Sequence : 1 angle 、3 edges and 6 faces Cycles: 1	1 Carton
8	ESD (Non-operation)	Air discharge model, ±8kV, 10 times	5

Test and measurement conditions

1. All measurements shall not be started until the specimens attain to temperature stability.
2. The degradation of Polarizer are ignored for item 1, 4 & 5.

Evaluation criteria

1. The function test is OK.
2. No observable defects.
3. Luminance: > 50% of initial value.
4. Current consumption: within $\pm 50\%$ of initial value.

11. EXTERNAL DIMENSION

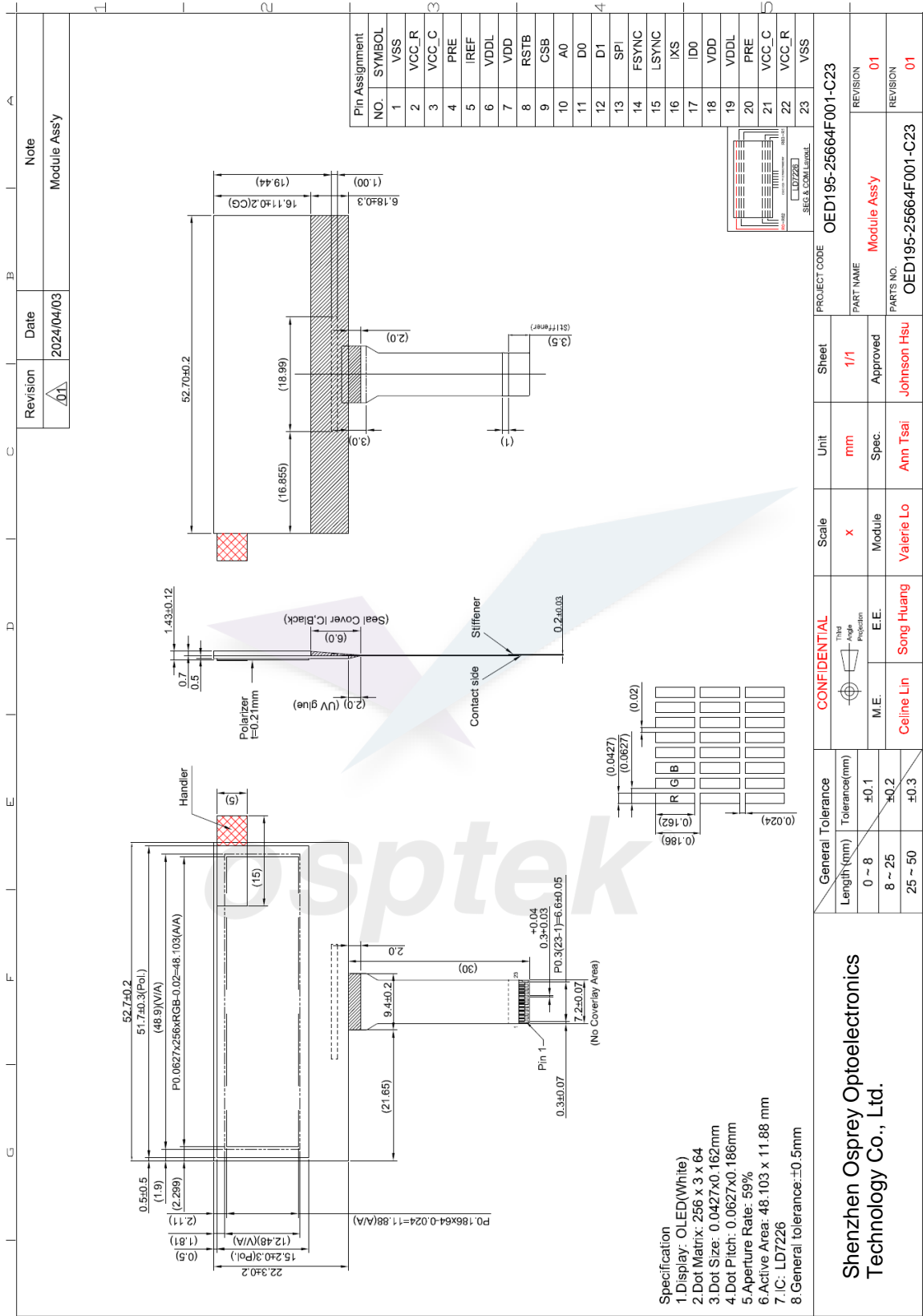

12. PACKING SPECIFICATION

TBD



13. OUTGOING INSPECTION PROVISION

1. 抽樣方法 / SAMPLING METHOD

- (1) MIL-STD-1916 / 驗證水準 level III / 正常檢驗 / 單次樣品檢驗
MIL-STD-1916 / inspection level III / normal inspection / single sample inspection
- (2) 主要缺陷 Level III ; 次要缺陷 Level II
Major Level III ; Minor Level II

MIL-STD-1916 樣本代字對照表							
批量	驗證水準 (VL)						
	VII	VI	V	IV	III	II	I
2 ~ 170	A	A	A	A	A	A	A
171 ~ 288	A	A	A	A	A	A	B
289 ~ 544	A	A	A	A	A	B	C
545 ~ 960	A	A	A	A	B	C	D
961 ~ 1632	A	A	A	B	C	D	E
1633 ~ 3072	A	A	B	C	D	E	E
3073 ~ 5440	A	B	C	D	E	E	E
5441 ~ 9216	B	C	D	E	E	E	E
9217 ~ 17408	C	D	E	E	E	E	E
17409 ~ 30720	D	E	E	E	E	E	E
≥ 30721	E	E	E	E	E	E	E

樣本代字 (CL)	驗證水準(VL)							
	T	VII	VI	V	IV	III	II	I
	樣本大小							
A	3072	1280	512	192	80	32	12	5
B	4096	1536	640	256	96	40	16	6
C	5120	2048	768	320	128	48	20	8
D	6144	2560	1024	384	160	64	24	10
E	8192	3072	1280	512	192	80	32	12

2. 檢驗條件 / INSPECTION CONDITION

檢查和測量在下列條件下進行的，除非另有規定。

The inspection and measurement are performed under the following conditions, unless otherwise specified.

溫度 / Temperature: $25\pm 5^{\circ}\text{C}$

濕度 / Humidity: $45\pm 15\%\text{R.H.}$

壓力 / Pressure: 860~1060hPa (mbar)

檢驗員拿的面板和眼睛之間的距離 / Distance between the panel and eyes of the inspector $\geq 30\text{cm}$



3. 品質檢驗規格 / SPECIFICATION FOR QUALITY CHECK

3.1 缺陷分類 / DEFECT CLASSIFICATION

嚴重度 Severity	檢驗項目 Inspection Item	缺陷 Defect	備註 Remark
主要缺陷 Major Defect	1. 面板 Panel	(1) 無顯示 Non-displaying	
		(2) 線缺陷 Line defects	
		(3) 故障 Malfunction	
		(4) 玻璃破損 Glass cracked	
	2. 軟板 Film	(1) 軟板尺寸超規 Film dimension out of specification	不能組裝 Can not be assembled
3. 尺寸 Dimension	(1) 外形尺寸超規 Outline dimension out of specification		
次要缺陷 Minor Defect	1. 面板 Panel	(1) 玻璃刮傷 Glass scratch	外觀缺陷 Appearance defect
		(2) 玻璃切割異常 Glass cutting NG	
		(3) 玻璃崩邊、崩角 Glass chip	
	2. 偏光板 Polarizer	(1) 偏光板刮傷 Polarizer scratch	
		(2) 表面汙漬 Stains on surface	
		(3) 偏光板氣泡 Polarizer bubbles	
	3. 顯示 Displaying	(1) 暗點、亮點、髒污 Dim spot·Bright spot·dust	
	4. 軟板 Film	(1) 損傷 Damage	
		(2) 異物 Foreign material	

3.2 出貨規格 / OUTGOING SPECIFICATION

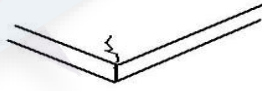
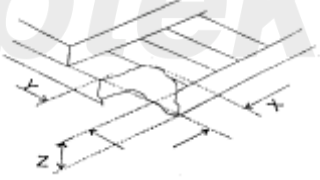
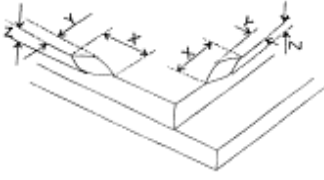
項目 Item	描述 Description	標準 Criterion	允收 水準 AQL															
I. 面板 Panel	1. 玻璃刮傷 Glass scratch	<table border="1"> <thead> <tr> <th>寬 / Width (mm) W</th> <th>長 / Length (mm) L</th> <th>容許個數 number of pieces permitted</th> </tr> </thead> <tbody> <tr> <td>$W \leq 0.05$</td> <td>忽略 Ignore</td> <td>忽略 Ignore</td> </tr> <tr> <td>$0.05 < W \leq 0.1$</td> <td>$L \leq 5$</td> <td>3</td> </tr> <tr> <td>$0.1 < W$</td> <td>-----</td> <td>無 None</td> </tr> <tr> <td>顯示區外 beyond A.A.</td> <td>-----</td> <td>忽略 Ignore</td> </tr> </tbody> </table>	寬 / Width (mm) W	長 / Length (mm) L	容許個數 number of pieces permitted	$W \leq 0.05$	忽略 Ignore	忽略 Ignore	$0.05 < W \leq 0.1$	$L \leq 5$	3	$0.1 < W$	-----	無 None	顯示區外 beyond A.A.	-----	忽略 Ignore	次要 Minor
	寬 / Width (mm) W	長 / Length (mm) L	容許個數 number of pieces permitted															
	$W \leq 0.05$	忽略 Ignore	忽略 Ignore															
$0.05 < W \leq 0.1$	$L \leq 5$	3																
$0.1 < W$	-----	無 None																
顯示區外 beyond A.A.	-----	忽略 Ignore																
2. 玻璃破損 Glass crack	<p>(1) 裂紋 / Crack 擴展裂紋是不能接受的。 Propagation crack is not acceptable.</p> 	主要 Major																
3. 玻璃崩邊、崩角 Glass chip	<p>(1) 崩角 / Chip on corner</p>  <p>(2) 崩邊 / Chip on edge</p> 	次要 Minor																

項目 Item	描述 Description	標準 Criterion	允收 水準 AQL									
I. 面板 Panel	3. 玻璃崩邊、崩角 Glass chip	不可影響顯示功能 Pretermission when no influence on Display Function.	次要 Minor									
	4. 尺寸 Dimension	請參閱圖紙的規範。 Refer to the drawing of the spec	主要 Major									
II. 偏光板 Polarizer	1. 刮傷 Scratch	點狀按照“項目 II-3 偏光板氣泡”的標準。 Spot type in accordance with the criteria of “Item II-3. Polarizer bubble”. 線狀按照“項目 I-1 玻璃刮傷”的標準。 Line type in accordance with the criteria of “Item I-1. Glass scratch”.	次要 Minor									
	2. 表面汗漬 Stains on surface	表面汗漬無法用軟布或類似的清潔物輕輕擦拭去除。 Stains cannot be removed even when wiped lightly with a soft cloth or similar cleaning.	次要 Minor									
	3. 偏光板氣泡 Polarizer bubble	(mm) <table border="1" style="margin-left: auto; margin-right: auto;"> <thead> <tr> <th>尺寸 Size</th> <th>容許個數 number of pieces permitted</th> </tr> </thead> <tbody> <tr> <td>$\Phi \leq 0.2$</td> <td>忽略 Ignore</td> </tr> <tr> <td>$0.2 < \Phi \leq 0.5$</td> <td>3</td> </tr> <tr> <td>$0.5 < \Phi$</td> <td>0</td> </tr> <tr> <td>顯示區外 beyond A.A.</td> <td>忽略 Ignor</td> </tr> </tbody> </table>	尺寸 Size	容許個數 number of pieces permitted	$\Phi \leq 0.2$	忽略 Ignore	$0.2 < \Phi \leq 0.5$	3	$0.5 < \Phi$	0	顯示區外 beyond A.A.	忽略 Ignor
尺寸 Size	容許個數 number of pieces permitted											
$\Phi \leq 0.2$	忽略 Ignore											
$0.2 < \Phi \leq 0.5$	3											
$0.5 < \Phi$	0											
顯示區外 beyond A.A.	忽略 Ignor											

項目 Item	描述 Description	標準 Criterion	允收 水準 AQL									
III. 顯示 Displaying	1. 耗電 Power consumption	該模組的工作電流消耗不應超出產品規格書的規範。 The module operating current consumption should not go beyond the standard indicated in Product Specification	主要 Major									
	2. 像素尺寸 Pixel size	顯示像素的尺寸的公差應規格的±25%之內。 The tolerance of display pixel dimension should be within ±25% of specification.	次要 Minor									
	3. 顏色 Color	依據產品規格。 Refer to the product specification.	主要 Major									
	4. 亮度 Luminance	依據產品規格。 Refer to the product specification.	主要 Major									
	5. 暗點、亮點、 髒污 Dimming spot、Lighting spot、Dust	1. <table border="1" style="margin-left: 20px;"> <thead> <tr> <th>平均直徑 Average diameter D:(mm)</th> <th>容許個數 number of pieces permitted</th> </tr> </thead> <tbody> <tr> <td>$D \leq 0.1$</td> <td>忽略 Ignore</td> </tr> <tr> <td>$0.1 < D \leq \text{Pixel Pitch}$</td> <td>3</td> </tr> <tr> <td>$\text{Pixel Pitch} < D$</td> <td>0</td> </tr> <tr> <td>顯示區外 beyond A.A.</td> <td>忽略 Ignore</td> </tr> </tbody> </table> <p style="margin-left: 20px;">D=(長邊直徑 + 短邊直徑)/2 D=(long diameter + short diameter)/2 像素暗點是不允許。 Pixel off is not allowed.</p>	平均直徑 Average diameter D:(mm)	容許個數 number of pieces permitted	$D \leq 0.1$	忽略 Ignore	$0.1 < D \leq \text{Pixel Pitch}$	3	$\text{Pixel Pitch} < D$	0	顯示區外 beyond A.A.	忽略 Ignore
平均直徑 Average diameter D:(mm)	容許個數 number of pieces permitted											
$D \leq 0.1$	忽略 Ignore											
$0.1 < D \leq \text{Pixel Pitch}$	3											
$\text{Pixel Pitch} < D$	0											
顯示區外 beyond A.A.	忽略 Ignore											

項目 Item	描述 Description	標準 Criterion	允收 水準 AQL		
III. 顯示 Displaying	5. 暗點、亮點、 髒污 Dimming spot、Lighting spot、Dust	2.	次要 Minor		
		寬 width(mm) W		長 length(mm) L	容許個數 number of pieces permitted
		$W \leq 0.05$		忽略 Ignore	忽略 Ignore
		$0.05 < W \leq 0.1$		$L \leq 2$	3
		$0.1 < W$		-----	無 None
顯示區外 beyond A.A.	-----	忽略 Ignore			
IV. 軟板 Film	1. 尺寸 Dimension	軟板尺寸超規。 Film dimension out of Spec.	主要 Major		
	2. 損傷 Damage	破損；深刮傷；深摺痕；深壓痕或其他損害是不能接受的。 Crack; deep scratch; deep fold; deep pressure mark or other damage is not acceptable.	次要 Minor		
	3. 異物 Foreign material	導電異物附著在導線，軟板和玻璃之間的異物是不能接受的。 Conductive foreign material sticking to the leads, foreign material between film and glass are not acceptable.	次要 Minor		

14. APPENDIXES

APPENDIX 1: DEFINITIONS

A. DEFINITION OF CHROMATICITY COORDINATE

The chromaticity coordinate is defined as the coordinate value on the CIE 1931 color chart for R, G, B, W.

B. DEFINITION OF CONTRAST RATIO

The contrast ratio is defined as the following formula:

$$\text{Contrast Ratio} = \frac{\text{Luminance of all pixels on measurement}}{\text{Luminance of all pixels off measurement}}$$

C. DEFINITION OF RESPONSE TIME

The definition of turn-on response time T_r is the time interval between a pixel reaching 10% of steady state luminance and 90% of steady state luminance. The definition of turn-off response time T_f is the time interval between a pixel reaching 90% of steady state luminance and 10% of steady state luminance. It is shown in Figure 2.

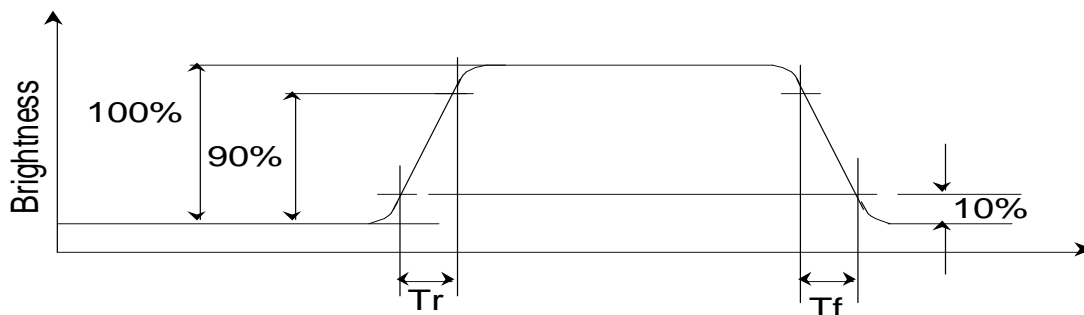

Figure 2: Response time

D. DEFINITION OF VIEWING ANGLE

The viewing angle is defined as Figure 3. Horizontal and vertical (H & V) angles are determined for viewing directions where luminance varies by 50% of the perpendicular value.

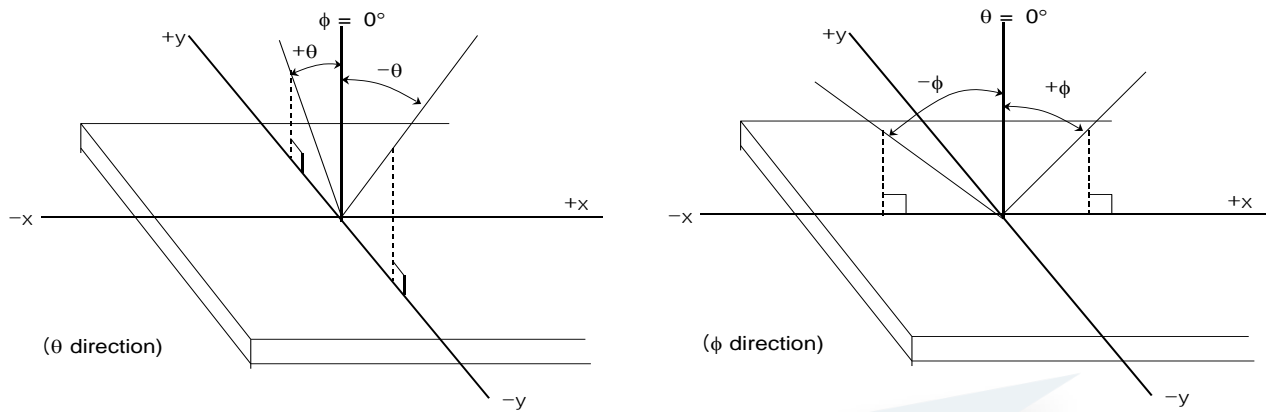

Figure 3: Viewing Angle

osptek[®]

APPENDIX 2: MEASUREMENT APPARATUS

A. LUMINANCE/COLOR COORDINATE

PHOTO RESEARCH PR-670, Konica Minolta CA-410

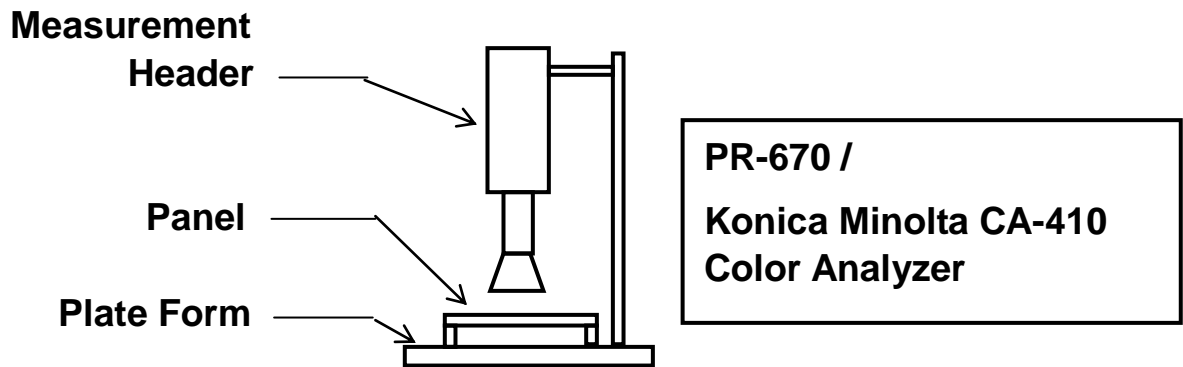

B. CONTRAST / RESPONSE TIME / VIEW ANGLE

WESTAR CORPORATION FPM-510

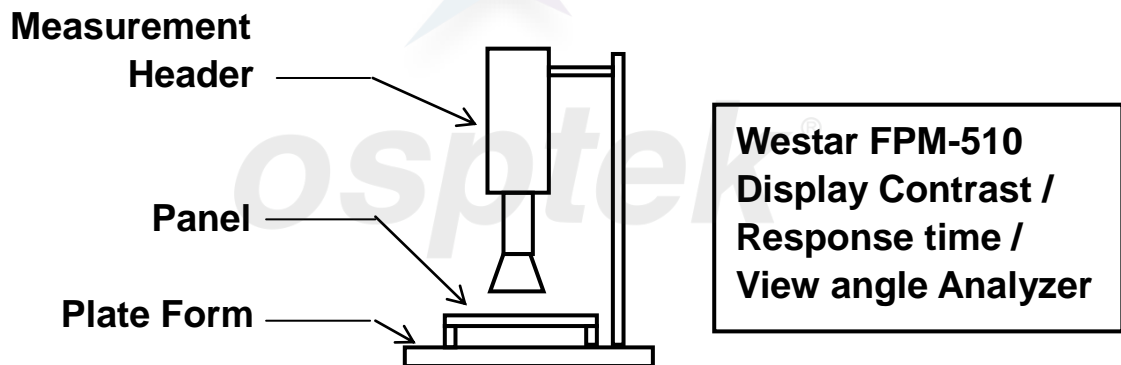

C. ESD ON AIR DISCHARGE MODE

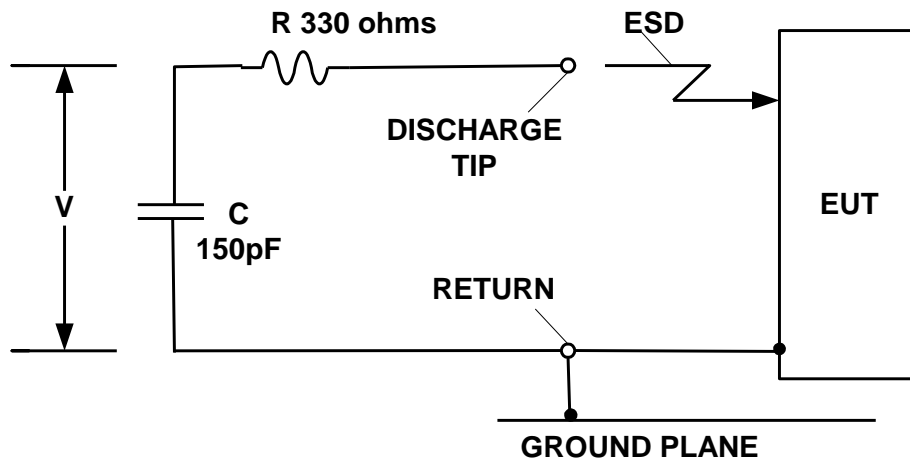

osptek[®]

APPENDIX 3: PRECAUTIONS FOR USING THE OLED MODULE

Precautions for Handling

1. When handling the module, wear powder-free anti static rubber finger cots/ anti-static clothing, anti-static gloves ,antistatic wrist strap and anti-static shoes

The environment should dispose the static elimination blower, anti-static pad, anti-static chair, and anti-static floor. The humidity maintains usually more than 40%



2. The OLED module is an electronic component and is subject to damage caused by Electro Static Discharge (ESD). And hence normal ESD precautions must be taken when handling it. Also, appropriate ESD protective environment must be administered and maintained in the production line. When handling and assembling the panel, wear an antistatic wrist strap with the alligator clip attached to the ground to prevent ESD damage on the panel. Antistatic wrist strap should touch human body directly instead of gloves. (See below photos).

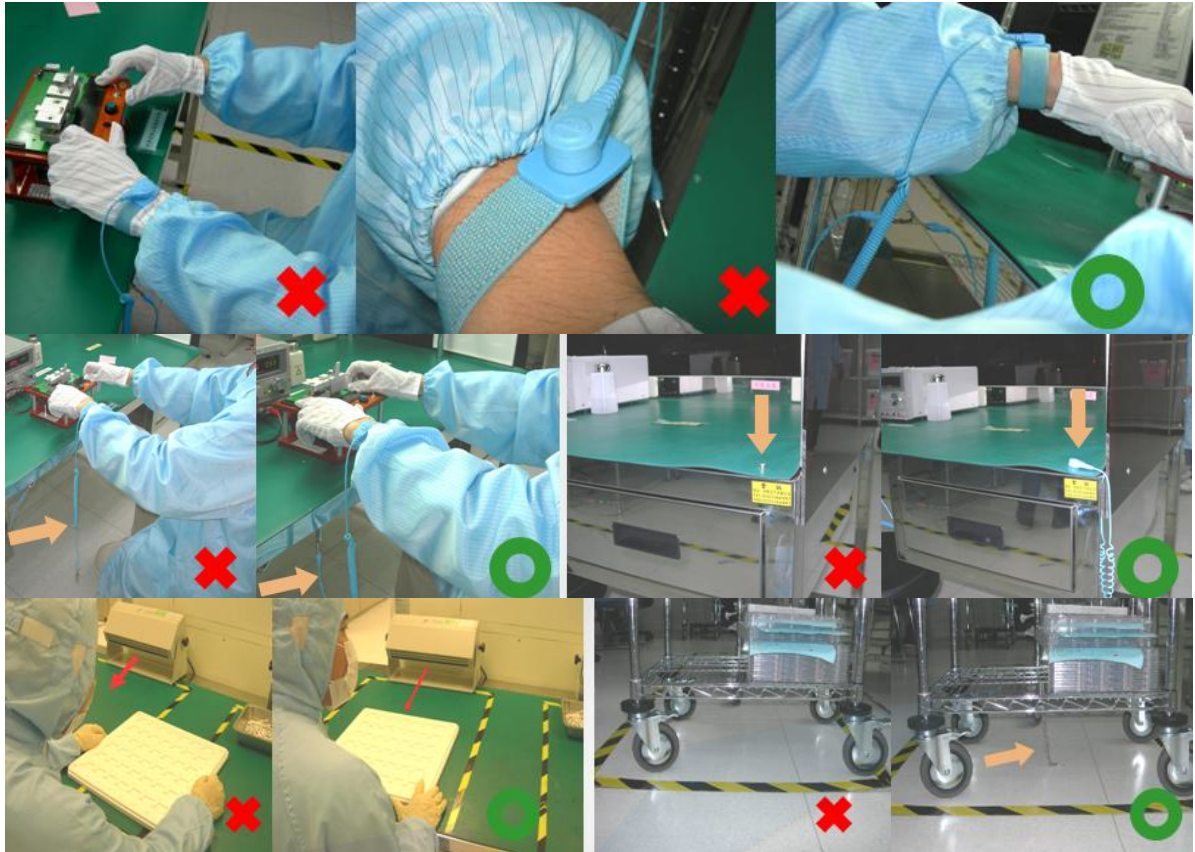

3. The OLED module is consisted of glass and film, and it should avoid pressure, strong impact, or being dropped from a high position.

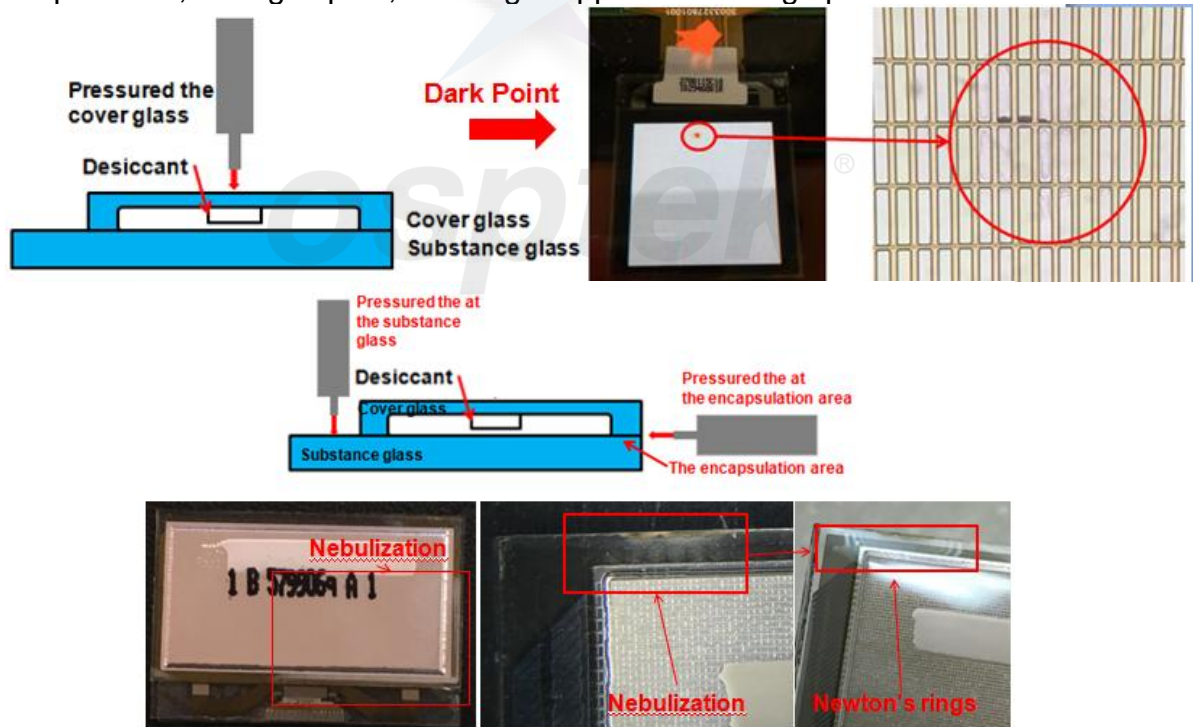

- Take out the panel one by one from the holding trays for assembly, and never put the panel on top of another one to avoid the scratch.

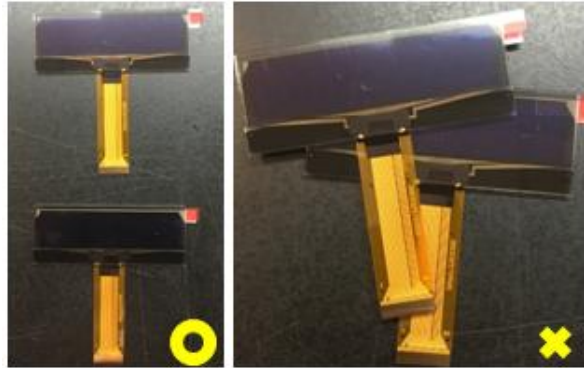

- Avoid jerk and excessive bend on TAB/FPC/COF, and be careful not to let foreign matter or bezel damage the film.
- When handling and assembling the module (panel + IC), grab the panel, not the TAB/FPC/COF.

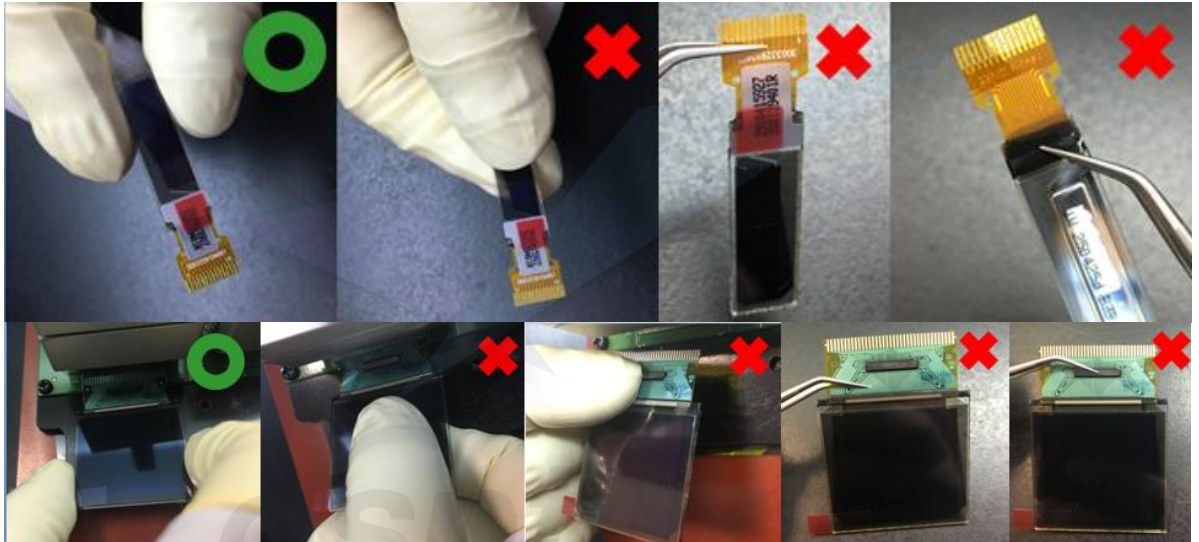

- Use the tweezers to open the clicks on the connector of PCB before the insertion of FPC/COF, and click them back in. Once the FPC/COF sits properly in the connector, use the tweezers to avoid the damages.



8. Please do not bend the film near the substrate glass. It could cause film peeling and TAB/FPC/COF damage. For TAB, It should bend the slit area as actual OLED it is. For FPC or COF, it is suggested to follow below pictures for instruction (distance between substrate glass and bending area $>1.5\text{mm}$; $R>0.5\text{mm}$).



9. Avoid bending the film at IC bonding area. It could damage the IC ILB bonding. It should avoid bending the IC seal area. Please keep the bending distance $>1.5\text{mm}$.

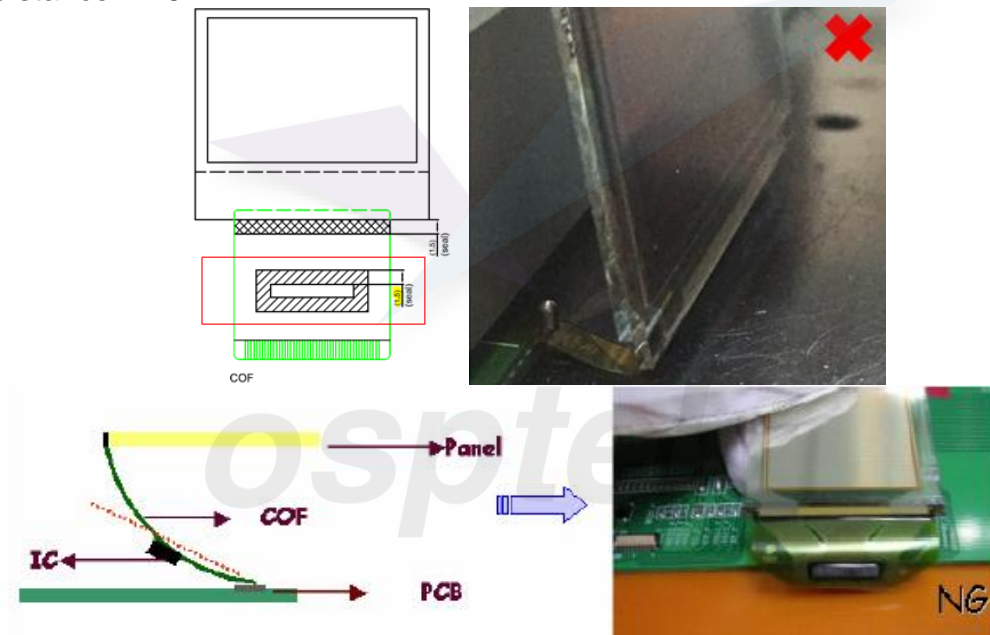

Use finger to insert COF /FPC into the connector when assembling the panel.
Please refer to the photo.

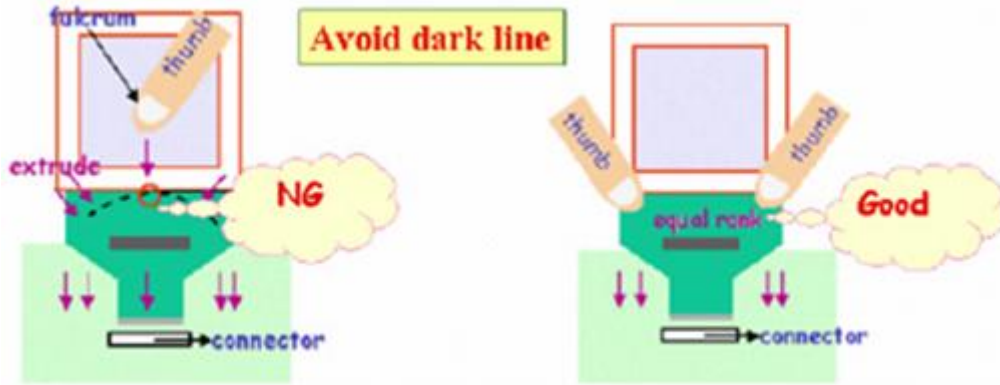

COF: Use both thumbs

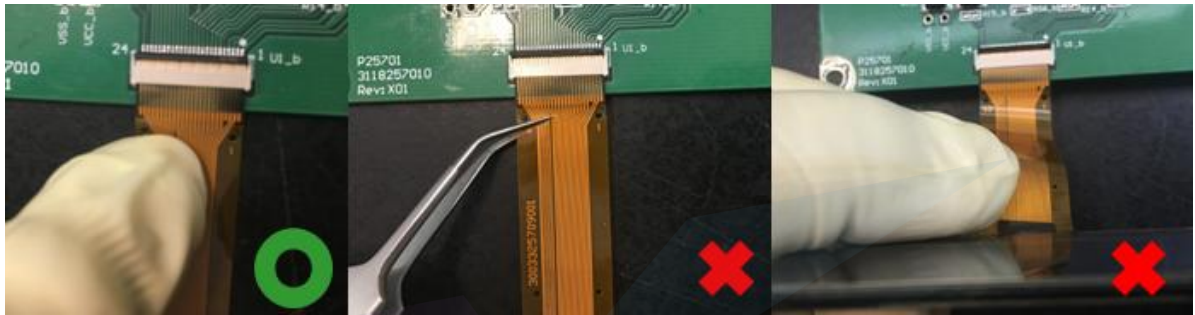

10. Do not wipe the pin of film and polarizer with the dry or hard materials that will damage the surface. When cleaning the display surface, use the soft cloth with solvent, IPA or alcohol, to clean.

11. Protection film is applied to the surface of OLED panel to avoid the scratch. Please remove the protective film before assembling it. If the OLED panel has been stored for a long time, the residue adhesive material of the protective film may remain on the display surface after remove the protective film. Please use the soft cloth with solvent, IPA or alcohol, to clean.

12. When hand or hot-bar soldering TAB/FPC onto PCB, make sure the temperature and timing profiles to meet the requirements of soldering specification (the specification depends on the application or optimized by customer) to prevent the damage of IC pins by inappropriate soldering, and also avoid the high temperature to damage the Organic light-emitting materials.

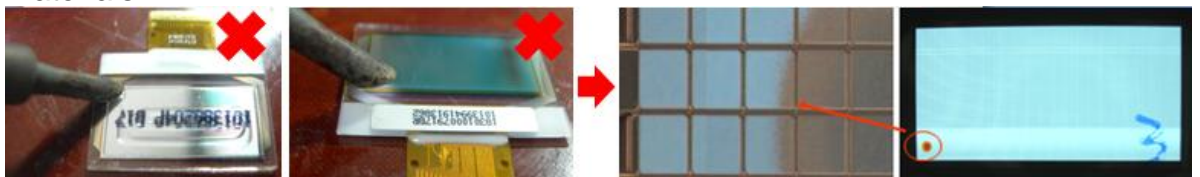

13. Solder residues arise from soldering process have to be cleaned up thoroughly before the module assembly.
14. Use the voltage and current settings listed in the specification to do the function test after the module assembly.

15. Suggestion for soldering process:

i. TAB Lead- free soldering hot bar process

1. Use pulse heated bonding tool equipment
2. Material: Sn/Ag/Cu lead-free solder paste with typical 25um thickness on PCB pad. The TAB pin size and shape may be different, please base on the production line to adjust the thickness of PCB pad and temperature.S
3. Bonding Force:--4kg per centimeter square as the starting point.
4. Suggested bonding tool temperature & time profile is as below for reference. Since there are differences in TAB soldering pins, soldering technicians' skills, mechanism...etc., the soldering conditions must be adequately tuned.

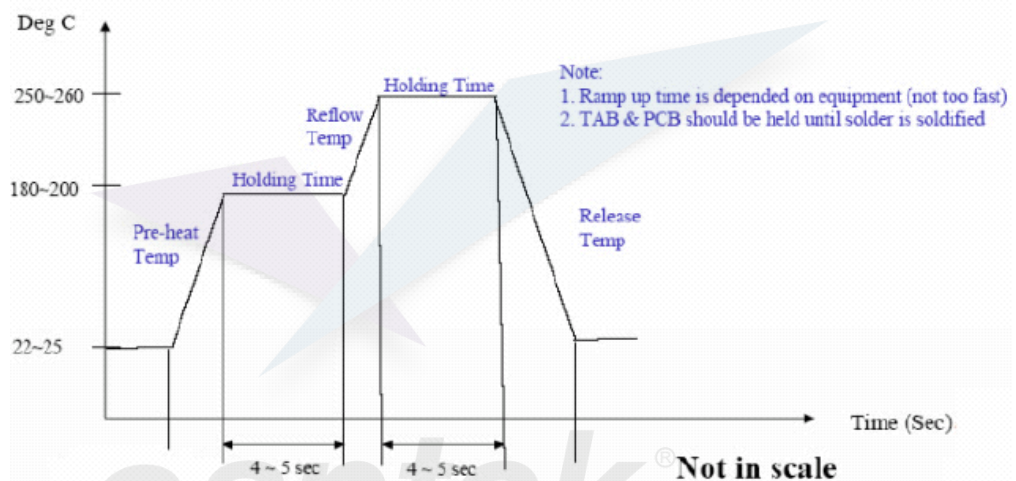

ii. TAB Lead- free soldering wire process

In case of manual soldering (Lead- free solder wire)

1. Solder wire contact iron directly: $280 \pm 5^{\circ}\text{C}$ at 3-5secs
2. Solder wire contact TAB lead directly (near iron but not contact): $380 \pm 5^{\circ}\text{C}$, 3-5secs
3. Since there are differences in TAB soldering pins, soldering technicians' skills, mechanism...etc., the soldering conditions must be adequately tuned.

- iii. High temperature will result in rapid heat conduction to IC and might cause damage to IC, so please keep the temperature below 380°C . Also, avoid damaging the polyimide and solder resist which might take place at high temperatures. Refold cycles base on the de-soldering status, if the plating of pin was damaged, it can not be used again.

Precautions for Electrical

1. Design using the settings in the specification

It is very important to design and operate the panel using the settings listed in the specification. It includes voltage, current, frame rate and duty cycle... etc. Operation the OLED outside the range of the specification should be entirely avoided to ensure proper operation of the OLED.

2. Maximum Ratings

To ensure the proper operation of the panel, never design the panel with parameters running over the maximum ratings listed in the specification. Also the logic voltages such as VIL and VIH have to be within the specified range in the specification to prevent any improper operation of the panel.

3. Power on/off procedure

To avoid any inadvertent effects resulting from inappropriate power on/off operations, please follow the directions of power on/off procedure on 9.1 POWER ON / OFF SEQUENCE.

Any operation that does not comply with the procedure could cause permanent damage of the IC and should be avoided. When the logic power is not on, do not activate any input signal. Abrupt shutdown of power to the module, while the OLED panel is on, would cause OLED panel malfunction.



4. Power savings

To save power consumption of the OLED, please use partial display or sleep mode when the panel is not fully activated. Also, if possible, make the black background to save power.

The OLED is a self-luminous device and a particular pixel cluster or image can be lit on via software control. So power savings can be achieved by partial display or dimming down the luminance. Depending on the application, the user can choose among Ultra Bright Mode, Normal Operation Mode, and Sleeping Mode. The power consumption is almost in directly proportion to the brightness of the panel, and also in directly proportion to the number of pixels lit on the panel. The customer can save the power by the use of black background and sleeping mode. One benefit from using these design schemes is the extension of the OLED lifetime.

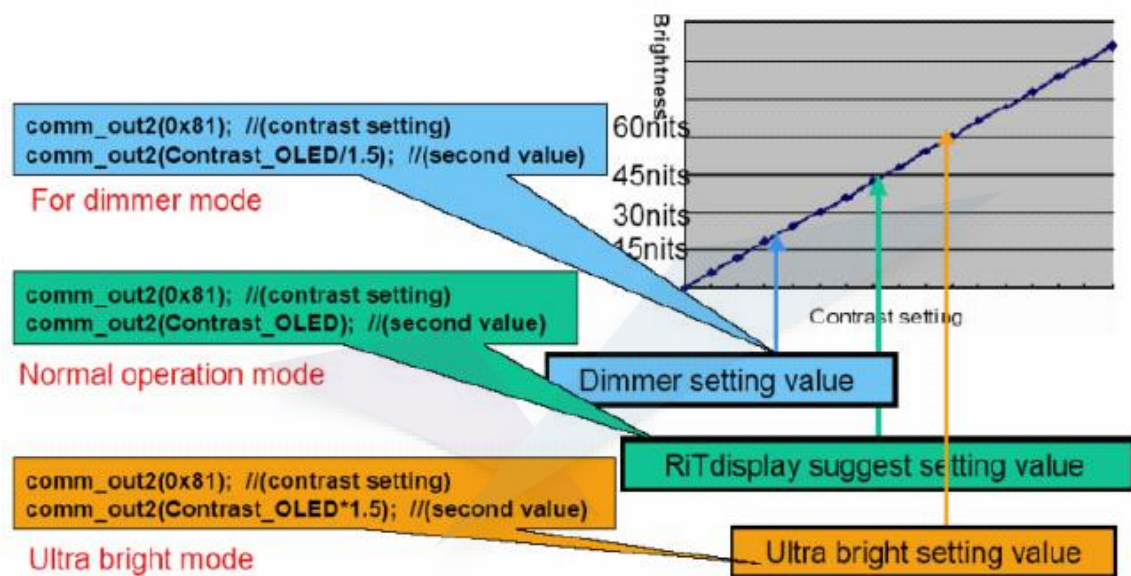

5. Adjusting the luminance of the panel

Although there are a couple of ways to adjust the luminance of the panel, it is strongly recommended that the customer change the contrast setting to adjust the luminance of the panel. Adjusting voltages to achieve desired luminance is not allowed. Be aware that the adjustment of luminance would accompany the change of lifetime of the panel and its power consumption as well.

6. Residual Image (Image Sticking)

The OLED is a self-emissive device. As with other self-emissive device or displays consisting of self-emissive pixels, when a static image frozen for a long period of time is changed to another one with all-pixels-on background, residual image or image sticking is noticed by the human eye. Image sticking is due to the luminance difference or contrast between the pixels that were previously turned on and the pixels that are newly turned on. Image sticking depends on the luminance decay curve of the display. The slower the decay, the less prominent the image sticking is. It is strongly recommended that the user employ the following four strategies to minimize image sticking.

1. Employ image scrolling or animation to even out the lit-on time of each and every pixel on the display, also could use sleeping mode for reduced the residual image and extend the power capacity.
2. Minimize the use of all-pixels-on or full white background in their application because when the panel is turned on full white, the image sticking from previously shown patterns is the most revealing. Black background is the best for power savings, greatest visibility, eye appealing, and dazzling displays.
3. Avoid displaying the characters or menu with high brightness level in a fix position for a long time or repeatedly. If necessary, using the auto fadeout technology. V_{CC_C} e the pattern into its inverse (i.e., turn off the while pixels and turn on the previously unlit pixels) and freeze the inverse pattern as long as the original logo is used, so every pixel on the panel can be lit on for about the same time to minimize image sticking, caused by the differential turn-on time between the original and its reverse patterns.



Scrolling example

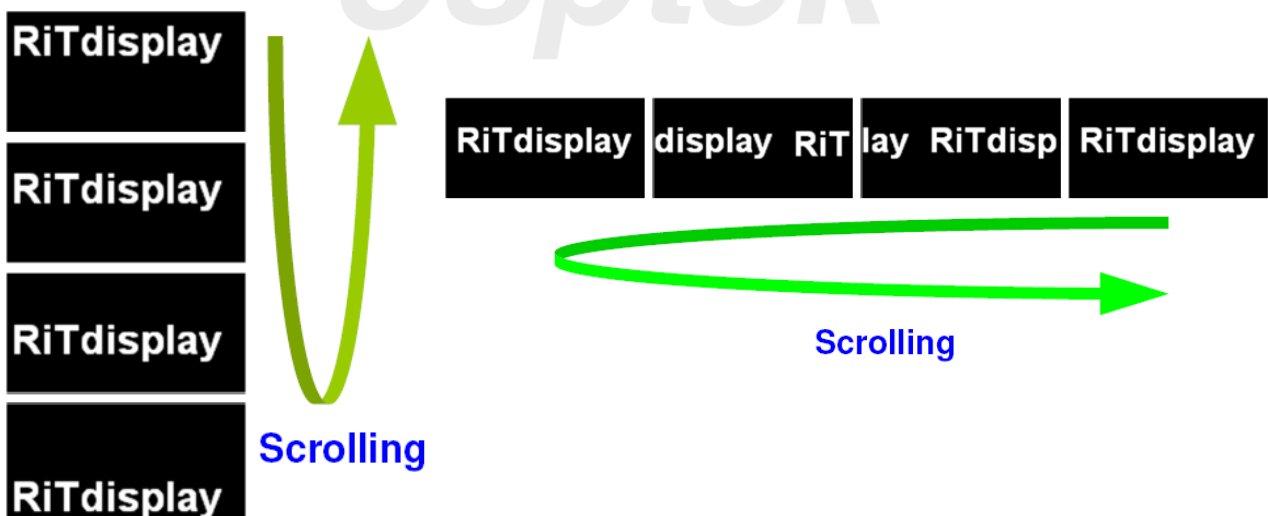

Precautions for Mechanical

1. Cushion or Buffer tape on the cover glass

It is strongly recommended to have a cushion or buffer tape to apply on the panel backside and front side when assembling OLED panel into module to protect it from damage due to excessive extraneous forces.

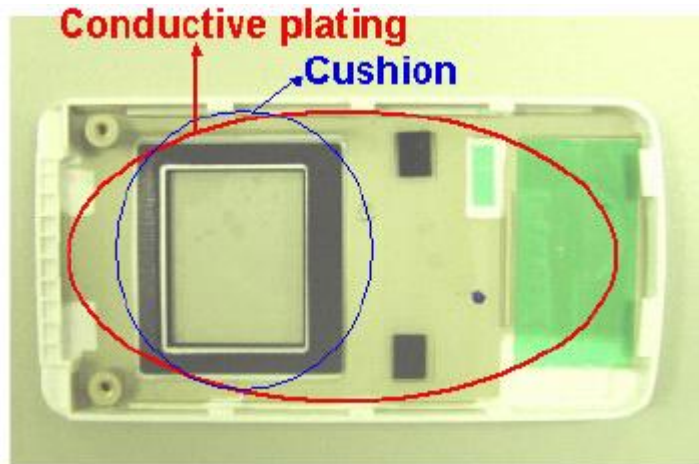

It is recommended that a plating conductive layer be used in the housing for EMI/EMC protection. And, the enough space should be reserved for the IC placement if the IC thickness is thicker than the TAB film when customer design the PCB.

2. Avoid excessive bending of film when handling or designing the panel into the product

The bending of TAB/COF/FPC has to follow the precautions indicated in the specification, extra bending or excessive extraneous forces should be avoided to minimize the chances of film damage. If bending the film is necessary, please bend the designated bending area only. Please refer to items 8 and 9 of Precautions for Handling for more information.

Precautions for Storage and Reliability Test

1. Storage

Store the packed cartons or packages at $25^{\circ}\text{C}\pm 5^{\circ}\text{C}$, $55\%\pm 10\%\text{RH}$. Do not store the OLED module under direct sunlight or UV light. For best panel performance, unpack the cartons and start the production of the panels within six months after the reception of them.

2. Reliability Test

Osptek only guarantees the reliability of the OLEDs under the test conditions and durations listed in the specification.

